



CARATTERISTICHE TECNICHE

- > La serie è costituita da 15 grandezze con diametro girante da 310 a 1410 mm
- > Serie caratterizzata dall'estrema robustezza della costruzione essenzialmente dovuta alle flange ricavate direttamente dalla virola (e non riportate), e dallo spessore dei materiali utilizzati
- > Varietà di versioni e di modelli che permette la soluzione idonea a numerosi problemi di ventilazione
- > La girante prevede un robusto mozzo a morsa, in fusione d'alluminio per il fissaggio delle pale
- > Pale realizzate mediante stampaggio di diversi materiali aventi sempre l'obiettivo di sopportare elevati carichi di lavoro
- > Convogliatore in lamiera d'acciaio protetto con verniciatura epossipoliestirica
- > Flange dimensionate a norma UNI ISO 6580 / EUROVENT 1-2.
- > Girante ad alto rendimento con pale a profilo alare, ad angolo di calettamento variabile da fermo, in tecnopolimero oppure in fusione d'alluminio, mozzo in fusione d'alluminio
- > Equilibratura secondo norme UNI ISO 1940.
- > Motore elettrico asincrono a corrente alternata, protezione IP 55, isolamento CI F, servizio S1, forma B3, costruzione conforme alle specifiche norme IEC / EEC (UNEL-MEC)
- > Esecuzione 4 (accoppiamento diretto con girante a sbalzo)
- > Versioni con girante avente pale in alluminio
- > Versioni Atex

SETTORI DI IMPIEGO

- > Ideali per impieghi in cui necessitano grandi portate d'aria e pressioni relativamente modeste, in applicazioni con fissaggio a canalizzazioni
- > Ventilazione e condizionamento industriale in applicazioni minerarie, navali, torri evaporative, scambiatori di calore, raffreddamento di apparecchiature elettriche, frigorifere ecc.

AREAS OF USE

- > Suitable when large air capacities with relatively low pressures are required in duct mounted applications
- > Ventilation and conditioning in naval and mining applications, evaporative towers, heat exchangers, cooling of electric and refrigerating equipments, etc.

TECHNICAL FEATURES

- > This line consists of 15 sizes with impeller diameter from 310 up to 1410 mm
- > Line characterised by the extreme sturdiness of construction, thanks to the flanges directly bended on the casing, and the thickness of the materials
- > Variety of versions and models allows the solution of most of the problems of ventilation
- > Impeller consists of a strong hub, in die-cast aluminum alloy for the fixing of the blades
- > Available in different materials suitable for heavy duties
- > Casing in steel sheet protected with epoxy painting
- > Fixing flanges according to UNI-ISO 6580/EUROVENT 1-2 standards.
- > Impeller with high efficiency airfoil blades in plastic material or in die-cast aluminum alloy, hub in die-cast aluminum alloy
- > Balancing according to UNI ISO 1940
- > Asynchronous electric motor, protection IP 55, class F insulated, form B3, service S1 construction according to the IEC/EEC (UNEL-MEC) standard
- > Arrangement 4 (impeller directly coupled to motor shaft)
- > Versions with impeller with in die-cast aluminum blades
- > Explosion proof versions (Atex)



DATI TECNICI | TECHNICAL DETAILS

2 poli/poles (3000 rpm) - monofase/single-phase (1Ph-230V 50Hz)

Modello Model	Portata - Flow rate (m³/h)	Pm (kW)	In max (A)	Mot. (H)	Lp dB(A)
312/A M	3.500	0,25	1,7	63	70
352/A M *	5.250	0,55	4	71	74
402/A M *	8.200	1,1	8	80	79

4 poli/poles (1500 rpm) - monofase/single-phase (1Ph-230V 50Hz)

Modello Model	Portata - Flow rate (m³/h)	Pm (kW)	In max (A)	Mot. (H)	Lp dB(A)
314/A M	2.300	0,09	1	56	52
354/A M	3.200	0,09	1	56	56
404/A M *	4.000	0,12	1,1	63	61
404/B M *	5.200	0,18	1,4	63	62
454/A M *	6.500	0,25	1,8	71	65
454/B M *	7.600	0,37	3,3	71	66

2 poli/poles (3000 rpm) - trifase/three-phase (3Ph-400V 50Hz)

Modello Model	Portata - Flow rate (m³/h)	Pm (kW)	In max (A)	Mot. (H)	Lp dB(A)
312/A T	3.500	0,25	0,7	63	70
352/A T	5.250	0,55	1,6	71	74
402/A T	8.200	1,1	2,6	80	79

6 poli/poles (1000 rpm) - trifase/three-phase (3Ph-400V 50Hz)

Modello Model	Portata - Flow rate (m³/h)	Pm (kW)	In max (A)	Mot. (H)	Lp dB(A)
506/A T *	6.000	0,18	0,7	71	58
566/A T	8.500	0,25	1	71	62
636/A T	12.500	0,37	1,3	80	66
636/B T	14.000	0,75	2,2	90	65
716/A T	16.000	0,75	2,2	90	67
716/B T	17.000	1,10	3	90	66
806/A T	16.000	0,75	2,2	90	68
806/B T	19.000	1,1	3	90	68
806/C T	22.500	1,5	4	100	69
906/A T	25.000	1,5	4	100	75
906/B T	29.000	2,2	5	112	75
906/C T	32.000	2,2	5	112	75
1006/A T	27.000	1,5	4	100	79
1006/B T	33.000	2,2	5	112	79
1006/C T	41.000	3	7	132	80
1126/B T	45.000	4	9	132	83
1126/C T	54.000	5,5	12	132	83
1256/B T	61.000	7,5	15	160	87
1256/C T	73.000	11	22	160	88
1256/D T	85.000	11	22	160	88
1406/A T	115.000	18,5	35	200	91

4 poli/poles (1500 rpm) - trifase/three-phase (3Ph-400V 50Hz)

Modello Model	Portata - Flow rate (m³/h)	Pm (kW)	In max (A)	Mot. (H)	Lp dB(A)
314/A T	2.300	0,09	0,4	56	52
354/A T	3.200	0,09	0,4	56	56
404/A T *	4.000	0,12	0,5	63	61
404/B T	5.200	0,18	0,6	63	62
454/A T	6.500	0,25	0,8	71	65
454/B T	7.600	0,37	1,2	71	66
504/A T *	8.000	0,37	1,2	71	68
504/B T	9.000	0,55	1,6	80	69
564/A T *	10.000	0,55	1,6	80	71
564/B T	12.500	0,75	2	80	72
634/A T	13.000	0,75	2	80	75
634/B T	16.000	1,1	2,8	90	76
634/C T	17.000	2,2	5	100	76
714/A T	17.000	1,5	3,5	90	77
714/B T	20.500	2,2	5	100	77
714/C T	18.500	2,2	5	100	77
714/D T	23.500	3	6,5	100	79
804/A T	24.000	3	6,5	100	78
804/B T	29.000	4	8,2	112	79
804/C T	35.000	5,5	11	132	80
804/D T	40.000	7,5	15	132	80
904/A T	38.000	5,5	11	132	85
904/B T	43.000	7,5	15	132	86
904/C T	47.000	7,5	15	132	86
904/D T	52.500	9,2	18	132	86
1004/A T	41.000	5,5	11	132	88
1004/B T	50.000	7,5	15	132	89
1004/C T	59.000	11	21	160	89
1004/D T	65.000	15	27,8	160	90
1004/E T	72.500	18,5	32,6	180	90
1124/A T	80.000	18,5	32,6	180	93
1124/B T	87.000	22	38,8	180	94
1124/C T	100.000	30	53	200	94
1254/A T	95.000	22	38,8	180	97
1254/B T	110.000	30	53	200	98
1254/C T	125.000	37	64	225	98

* Solo per esportazione extra U.E. - * Only for-non Europeans market

8 poli/poles (750 rpm) - trifase/three-phase (3Ph-400V 50Hz)

Modello Model	Portata - Flow rate (m³/h)	Pm (kW)	In max (A)	Mot. (H)	Lp dB(A)
568/A T	6.000	0,12	0,7	71	56
638/A T *	8.000	0,18	0,8	80	60
718/A T *	11.000	0,37	1,5	90	61
808/A T *	10.000	0,37	1,5	90	61
808/B T *	13.000	0,37	1,5	90	62
908/A T	17.000	0,75	2,3	100	69
908/B T	20.500	0,75	2,3	100	69
1008/A T	20.500	0,75	2,3	100	74
1008/B T	25.000	1,1	3,4	100	74
1128/C T	40.500	2,2	5,5	132	77
1258/A T	34.500	2,2	5,5	132	81
1258/B T	43.000	3	7,3	132	81
1258/C T	52.000	4	9,3	160	82
1258/D T	59.000	4	9,3	160	82
1408/A T	87.000	7,5	14,7	160	85

Le prestazioni indicate nei diagrammi si riferiscono ad aria alla temperatura di 15°C ed all'altitudine di 0 mt s.l.m. , e sono state ottenute in installazioni di tipo "D" in assenza di reti e accessori.

Performance shown in the selection diagrams refer to air at 15°C temperature and 0 mt a.s.l. altitude, and they were obtained in installation type "D" with no grid nor accessories.



DATI TECNICI | TECHNICAL DETAILS

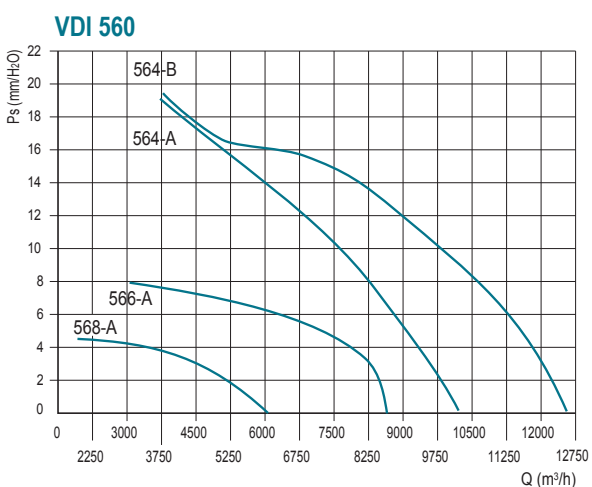
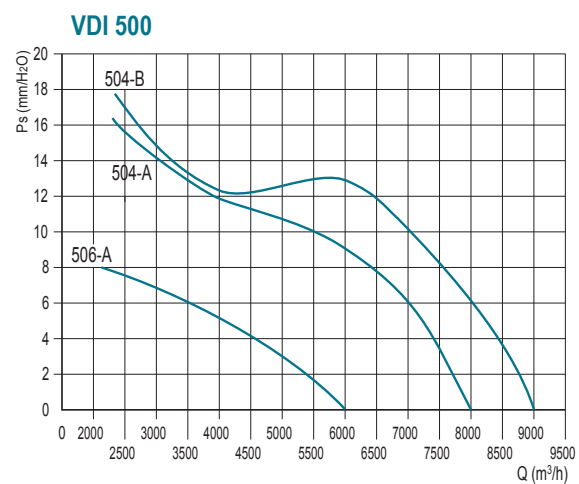
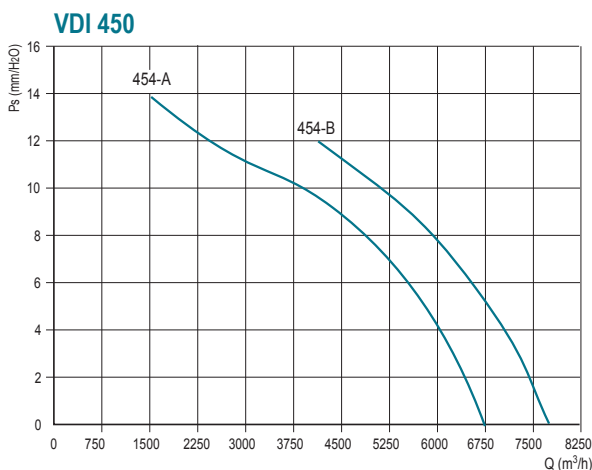
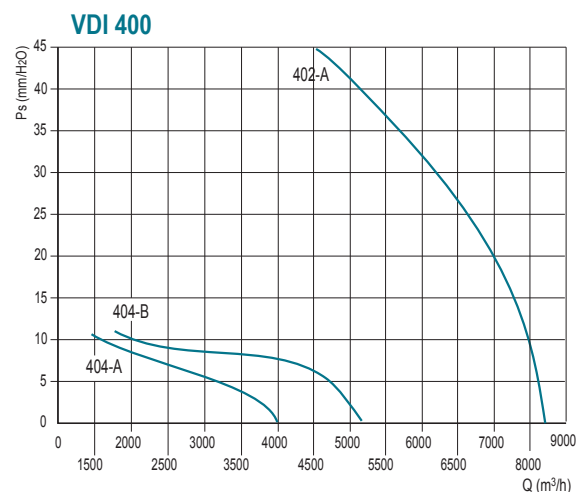
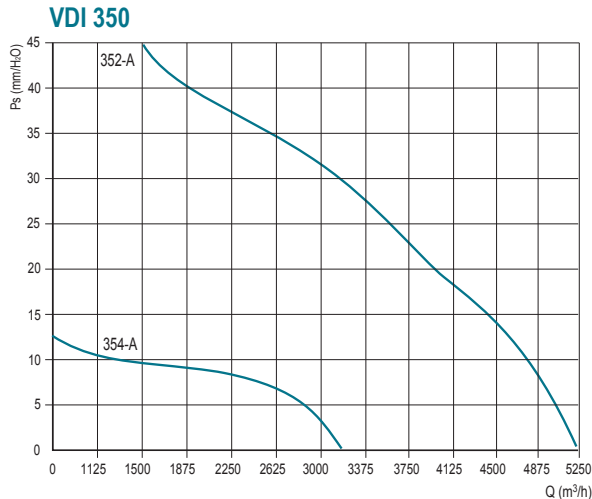
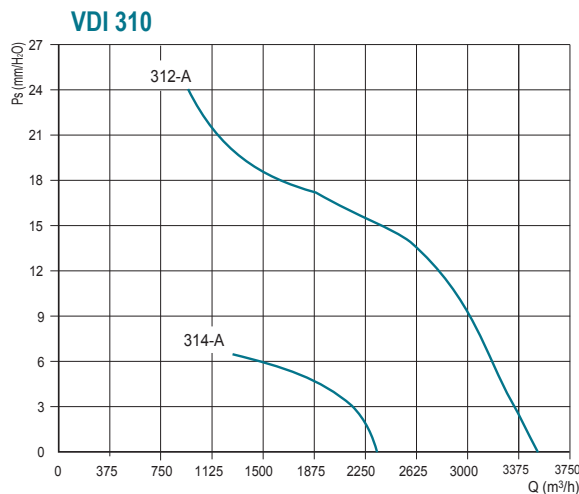

Le prestazioni indicate nei diagrammi si riferiscono ad aria alla temperatura di 15°C ed all'altitudine di 0 mt s.l.m., e sono state ottenute in installazioni di tipo "D" in assenza di reti e accessori.
Performance shown in the selection diagrams refer to air at 15°C temperature and 0 mt a.s.l. altitude, and they were obtained in installation type "D" with no grid nor accessories.



DATI TECNICI | TECHNICAL DETAILS

VDI 630

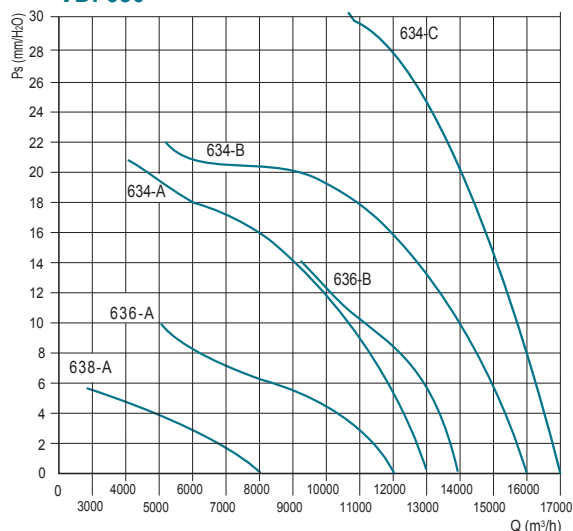

VDI 710

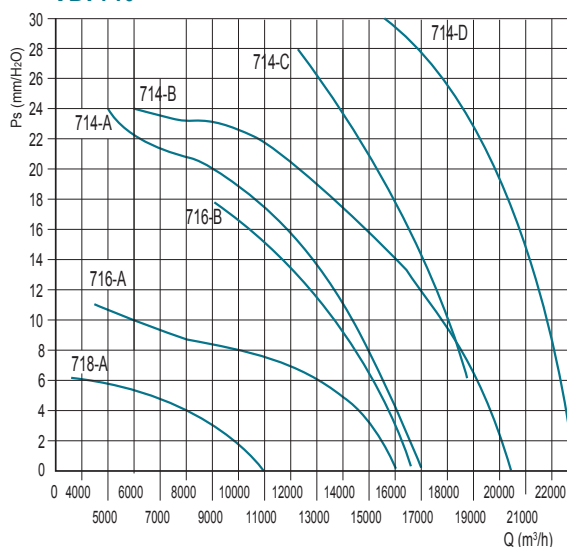

VDI 800 - 4 poles

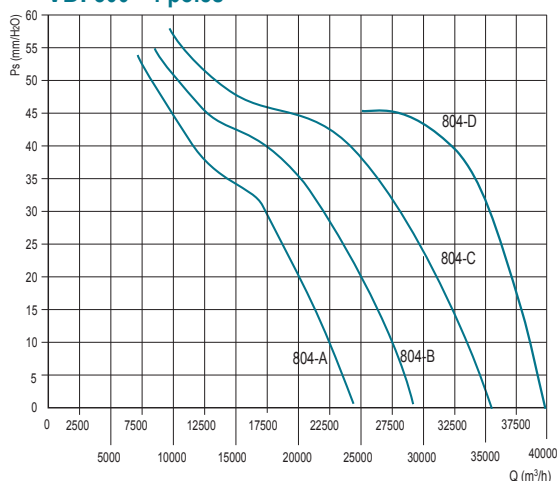

VDI 800 - 6 poles e 8 poles

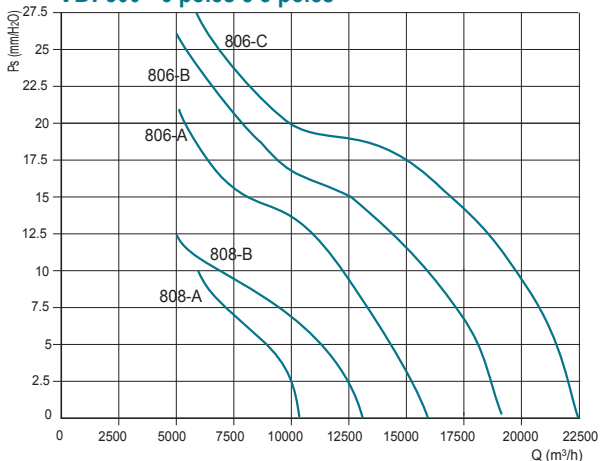

VDI 900 - 4 poles

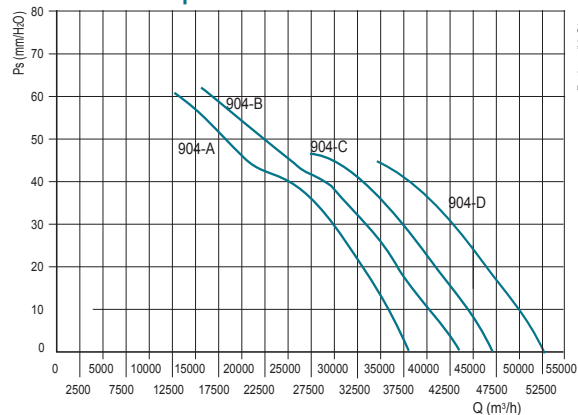

VDI 900 - 6 poles e 8 poles

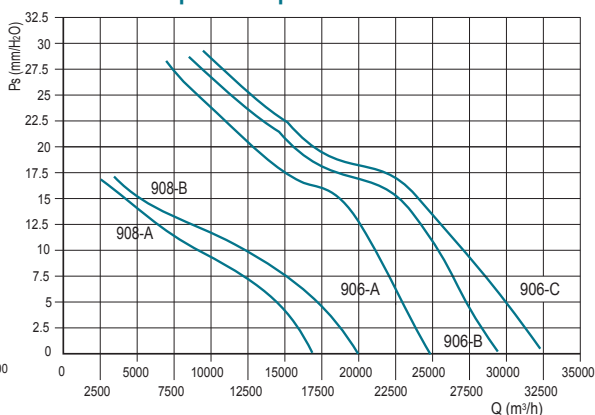

Le prestazioni indicate nei diagrammi si riferiscono ad aria alla temperatura di 15°C ed all'altitudine di 0 mt s.l.m. , e sono state ottenute in installazioni di tipo "D" in assenza di reti e accessori.
Performance shown in the selection diagrams refer to air at 15°C temperature and 0 mt a.s.l. altitude, and they were obtained in installation type "D" with no grid nor accessories.



DATI TECNICI | TECHNICAL DETAILS

VDI 1000 - 4 poles

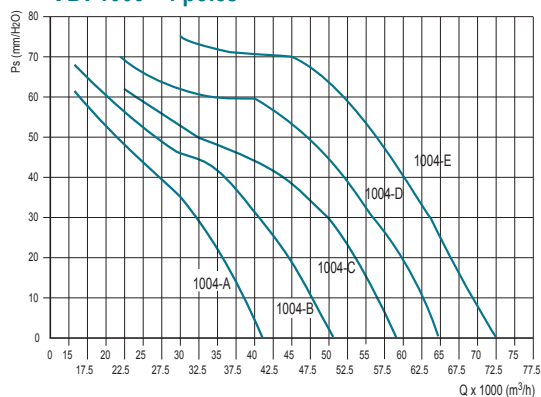

VDI 1000 - 6 poles e 8 poles

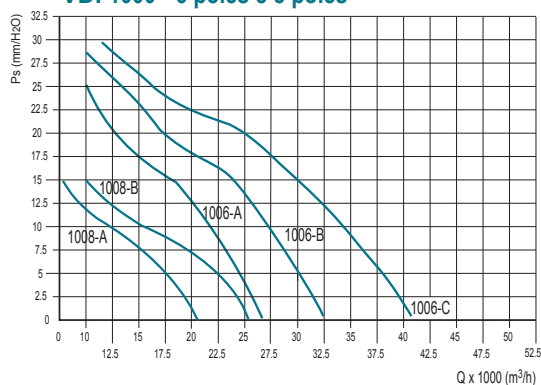

VDI 1120 - 4 poles

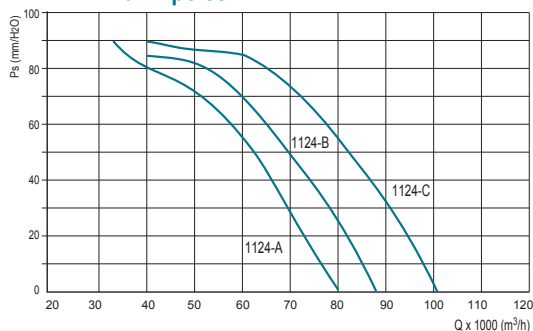

VDI 1120 - 6 poles e 8 poles

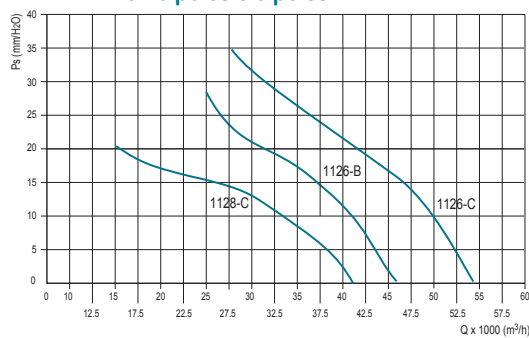

Le prestazioni indicate nei diagrammi si riferiscono ad aria alla temperatura di 15°C ed all'altitudine di 0 mt s.l.m., e sono state ottenute in installazioni di tipo "D" in assenza di reti e accessori.
Performance shown in the selection diagrams refer to air at 15°C temperature and 0 mt a.s.l. altitude, and they were obtained in installation type "D" with no grid nor accessories.



DATI TECNICI | TECHNICAL DETAILS

VDI 1250- 4 poles

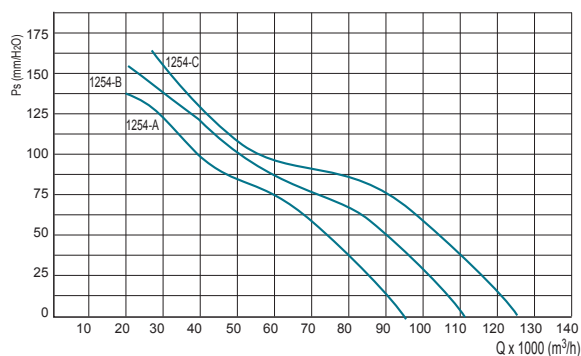

VDI 1250 - 6 poles

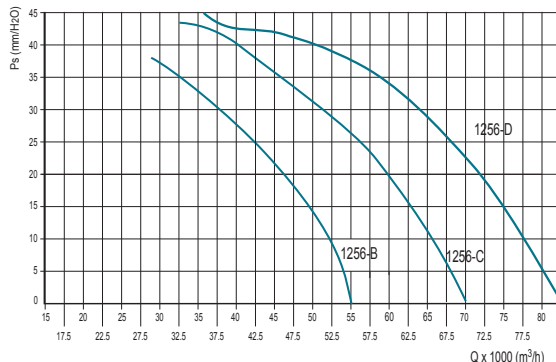

VDI 1250 - 8 poles

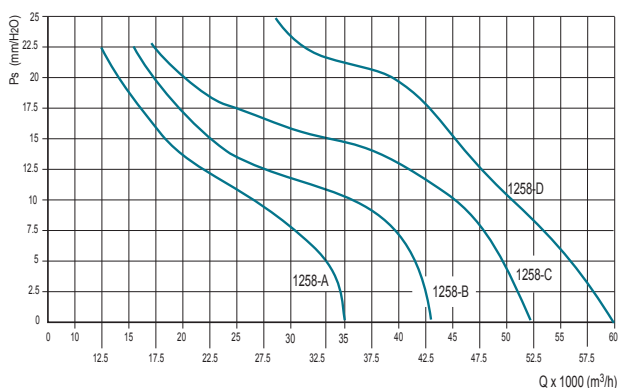

VDI 1400 - 6 poles

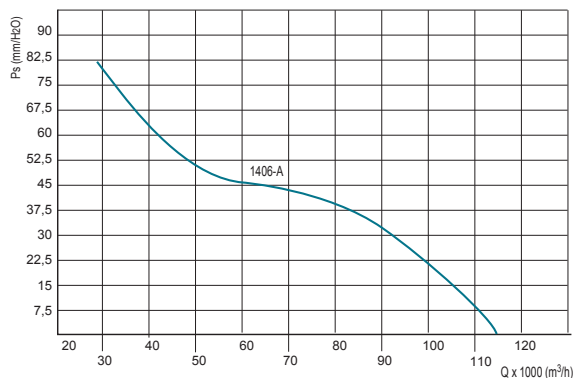

VDI 1400 - 8 poles

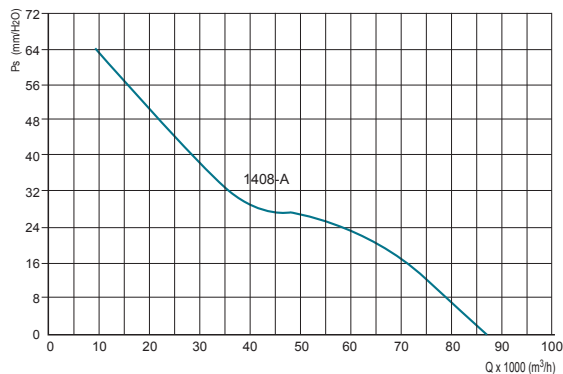

Le prestazioni indicate nei diagrammi si riferiscono ad aria alla temperatura di 15°C ed all'altitudine di 0 mt s.l.m. , e sono state ottenute in installazioni di tipo "D" in assenza di reti e accessori.
Performance shown in the selection diagrams refer to air at 15°C temperature and 0 mt a.s.l. altitude, and they were obtained in installation type "D" with no grid nor accessories.



SPECIFICHE TECNICHE

- > Aria convogliata: pulita o leggermente polverosa, non abrasiva
- > Temperatura aria convogliata: -20°C / +50°C
- > Tensione d'alimentazione: 400V trifase, 230V monofase, 50Hz
- > Flusso dell'aria da motore a girante

TECHNICAL SPECIFICATIONS

- > Conveyed air: clean, not abrasive
- > Temperature of conveyed air: -20°C / +50°C
- > Voltage: 400V-3Ph, 230V-1Ph, 50Hz
- > Air flow from motor to impeller

DIMENSIONI | DIMENSIONS

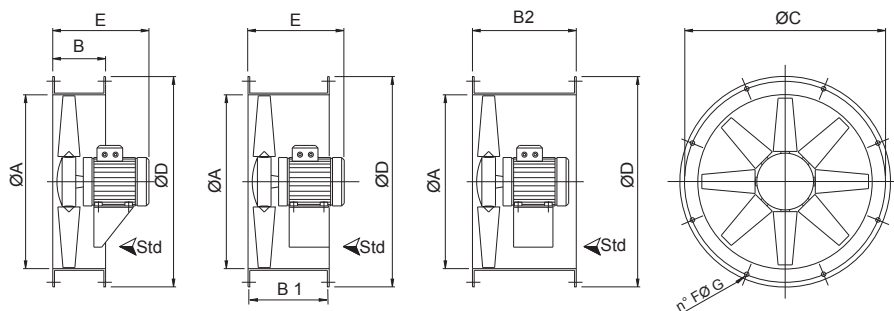

Model	A	B	B1	B2	C	D	*E	F	G	*kg (Ms)	*kg (Mm)	*kg (Ml)
31	310	260	260	400	355	390	250/320	8	10	13/17	13/17	13/19
35	360	260	260	400	395	430	250/320	8	10	14/19	14/19	14/22
40	410	260	260	400	450	490	300/380	8	12	16/24	16/24	19/27
45	460	260	260	450	500	540	350/390	8	12	21/30	21/30	23/33
50	510	260	260	450	560	600	350/390	12	12	24/35	24/35	27/38
56	570	260	260	450	620	655	350/390	12	12	28/37	28/37	34/43
63	640	260	350	500	690	725	400/490	12	12	34/51	37/54	44/61
71	710	260	350	600	770	805	400/490	16	12	41/62	44/67	53/77
80	810	350	450	600	860	905	450/610	16	12	50/105	54/110	60/115
90	910	350	450	700	970	1010	450/690	16	16	80/162	87/169	105/187
100	1010	-	560 800**	800 900**	1070	1115	700/830	16	16	92/235	107/250	123/266
			**(mot H 180)									
112	1130	-	560 800**	800 900**	1190	1235	700/880	20	16	120/250	136/260	157/360
			**(mot H 180-200)									
125	1260	-	560 800**	800 1000**	1320	1365	700/1000	20	16	-	169/356	192/450
			**(mot H 180-225)									
140	1400	-	800	1100	1470	1520	900/1000	20	16	-	380/480	426/526

Dimensioni in mm/Dimensions in mm
(*) Indicativo/Indicative

OPTIONAL

Codice Code	Descrizione	Description
IN	Boccaglio in aspirazione	Inlet nozzle
SIL-DU	Silenziatori	Silencers
FPG-DU (CPG-DU)	Rete antinfortunistica piana (conica)	Flat protection grid (conic)
FC-DU	Giunto antivibrante	Flexible connection
AV	Supporti antivibranti	Antivibration mounts
CF-DU	Controflangia	Counter flange
OTB	Morsetiera esterna	Outer terminal box
FF-DU	Piedi di fissaggio	Fixing feet
SW	Interruttore di servizio	Service switch
	Portello d'ispezione	Ispection door